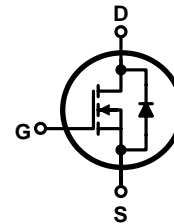
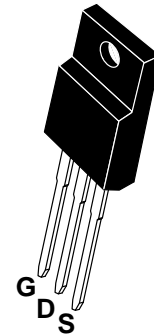
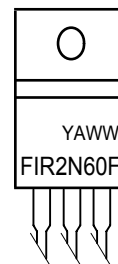

PIN Connection TO-220F
Switching Regulator Application
Features

- High Voltage: $BV_{DSS}=600V(\text{Min.})$
- Low C_{rss} : $C_{rss}=3.4F(\text{Typ.})$
- Low gate charge : $Q_g=7.0nC(\text{Typ.})$
- Low $R_{DS(on)}$: $R_{DS(on)}=4.7\Omega(\text{Max.})$

Marking Diagram

- Y = Year
- A = Assembly Location
- WW = Work Week
- FIR2N60F = Specific Device Code

Absolute maximum ratings ($T_c=25^\circ\text{C}$ unless otherwise noted) Advanced N-Ch Power MOSFET

Characteristic	Symbol	Rating	Unit
Drain-source voltage	V_{DSS}	600	V
Gate-source voltage	V_{GSS}	± 30	V
Drain current (DC) *	I_D	($T_c=25^\circ\text{C}$)	2.0
		($T_c=100^\circ\text{C}$)	1.35
Drain current (Pulsed) *	I_{DM}	6.0	A
Power dissipation	P_D	19.1	W
Avalanche current (Single) ②	I_{AS}	2.0	A
Single pulsed avalanche energy ②	E_{AS}	88	mJ
Avalanche current (Repetitive) ①	I_{AR}	2.0	A
Repetitive avalanche energy ①	E_{AR}	8	mJ
Junction temperature	T_J	150	$^\circ\text{C}$
Storage temperature range	T_{stg}	-55~150	

* Limited by maximum junction temperature

Characteristic	Symbol	Typ.	Max.	Unit
Thermal resistance	Junction-case	-	5.5	$^\circ\text{C/W}$
	Junction-ambient	-	62.5	

Electrical Characteristics ($T_C=25^\circ\text{C}$ unless otherwise noted)

Characteristic	Symbol	Test Condition	Min.	Typ.	Max.	Unit
Drain-source breakdown voltage	BV_{DSS}	$I_D=250\mu\text{A}, V_{GS}=0$	600	-	-	V
Gate threshold voltage	$V_{GS(th)}$	$I_D=250\mu\text{A}, V_{DS}=V_{GS}$	2.0	-	4.0	V
Drain-source cut-off current	I_{DSS}	$V_{DS}=600\text{V}, V_{GS}=0\text{V}$	-	-	1	μA
Gate leakage current	I_{GSS}	$V_{DS}=0\text{V}, V_{GS}=\pm 30\text{V}$	-	-	± 100	nA
Drain-source on-resistance ④	$R_{DS(on)}$	$V_{GS}=10\text{V}, I_D=1.0\text{A}$	-	7.0	8.0	Ω
Forward transfer conductance ④	g_{fs}	$V_{DS}=10\text{V}, I_D=1.0\text{A}$	-	5	-	S
Input capacitance	C_{iss}	$V_{GS}=0\text{V}, V_{DS}=25\text{V},$ $f=1\text{MHz}$	-	170	-	pF
Output capacitance	C_{oss}		-	27	-	
Reverse transfer capacitance	C_{rss}		-	5	-	
Turn-on delay time	$t_{d(on)}$	$V_{DD}=300\text{V}, I_D=2.0\text{A}$ $R_G=25\Omega$	-	8	-	ns
Rise time	t_r		-	30	-	
Turn-off delay time	$t_{d(off)}$ ③④		-	22	-	
Fall time	t_f		-	55	-	
Total gate charge	Q_g	$V_{DS}=480\text{V}, V_{GS}=10\text{V}$ $I_D=2.0\text{A}$	-	7.5	9.5	nC
Gate-source charge	Q_{gs}		-	1.7	-	
Gate-drain charge	Q_{gd} ③④		-	4.0	-	

Source-Drain Diode Ratings and Characteristics ($T_C=25^\circ\text{C}$ unless otherwise noted)

Characteristic	Symbol	Test Condition	Min.	Typ.	Max.	Unit
Source current (DC)	I_S	Integral reverse diode in the MOSFET	-	-	2.0	A
Source current (Pulsed) ①	I_{SM}		-	-	6.0	
Forward voltage ④	V_{SD}	$V_{GS}=0\text{V}, I_S=2.0\text{A}$	-	-	1.5	V
Reverse recovery time	t_{rr}	$I_S=2.0\text{A}, V_{GS}=0\text{V}$ $dI_F/dt=100\text{A}/\mu\text{s}$	-	250	-	ns
Reverse recovery charge	Q_{rr}		-	550	-	nC

Note ;

- ① Repetitive rating : Pulse width limited by maximum junction temperature
- ② $L=59.5\text{mH}, I_{AS}=2.0\text{A}, V_{DD}=50\text{V}, R_G=25\Omega$, Starting $T_J=25^\circ\text{C}$
- ③ Pulse Test : Pulse width $\leq 300\mu\text{s}$, Duty cycle $\leq 2\%$
- ④ Essentially independent of operating temperature

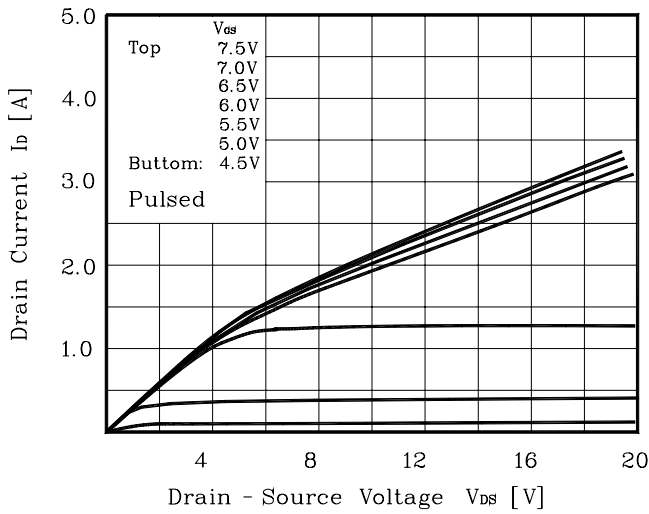
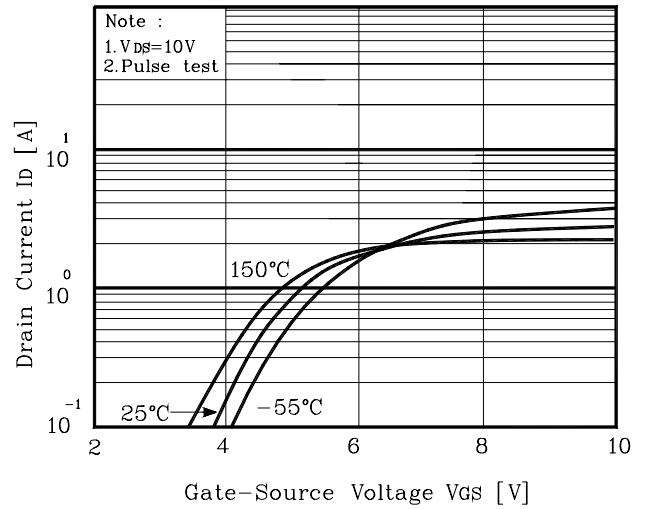
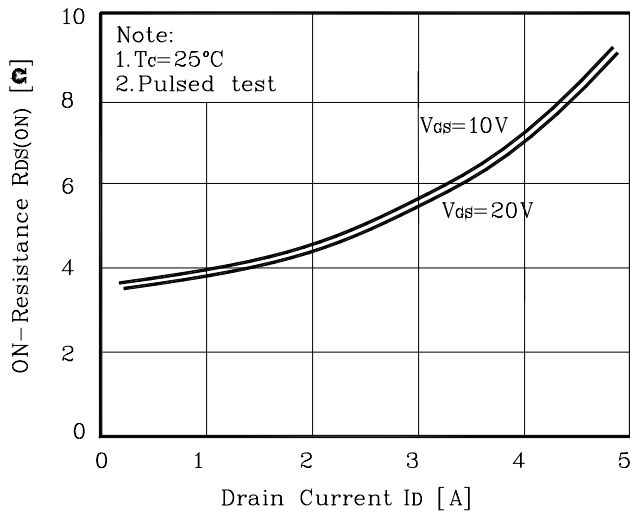
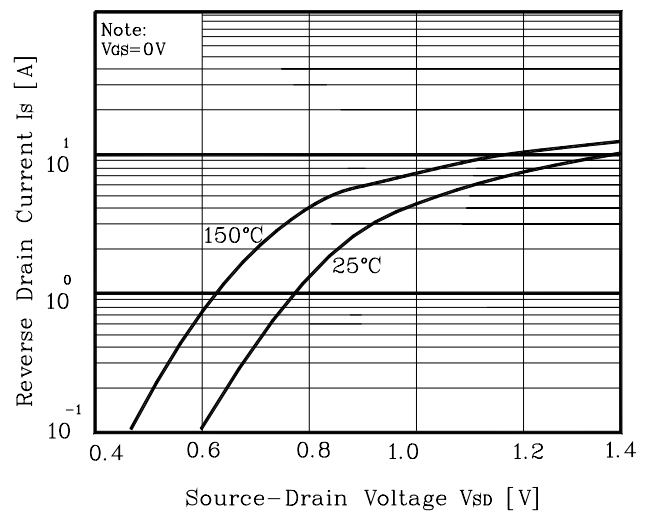
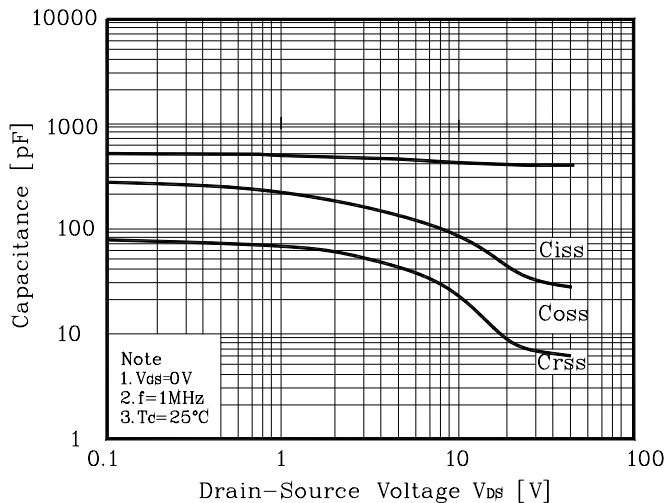
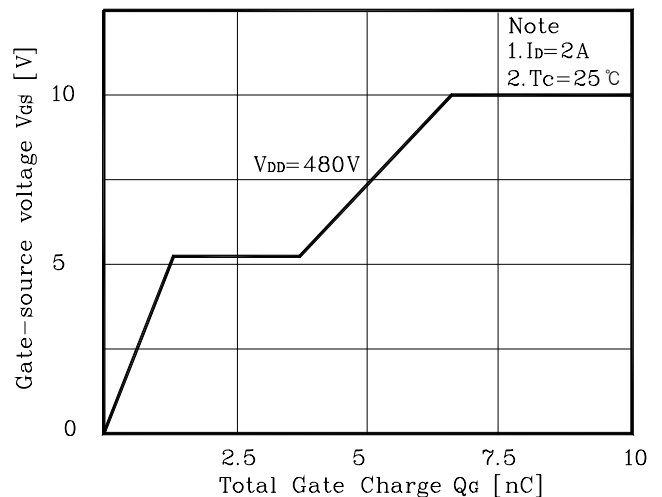
Electrical Characteristic Curves
Fig. 1 $I_D - V_{DS}$

Fig. 2 $I_D - V_{GS}$

Fig. 3 $R_{DS(on)} - I_D$

Fig. 4 $I_S - V_{SD}$

Fig. 5 Capacitance - V_{DS}

Fig. 6 $V_{GS} - Q_G$

Electrical Characteristic Curves
Fig. 7 $V_{DSS} - T_J$

Fig. 8 $R_{DS(on)} - T_J$

Fig. 9 $I_D - T_C$

Fig. 10 Safe Operating Area

Fig. 11 Gate Charge Test Circuit & Waveform

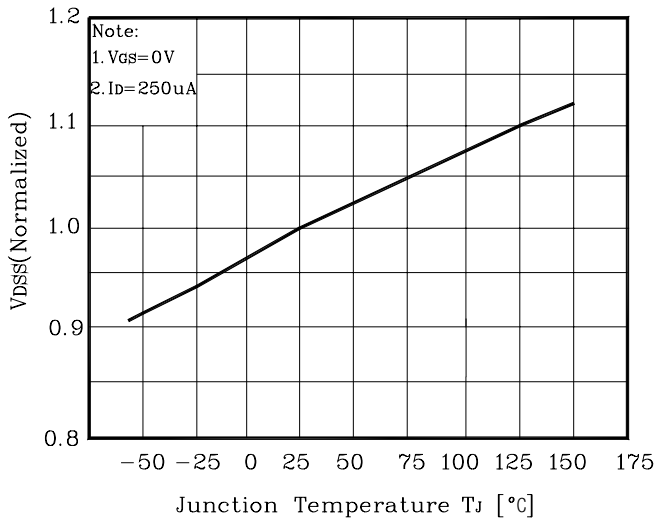
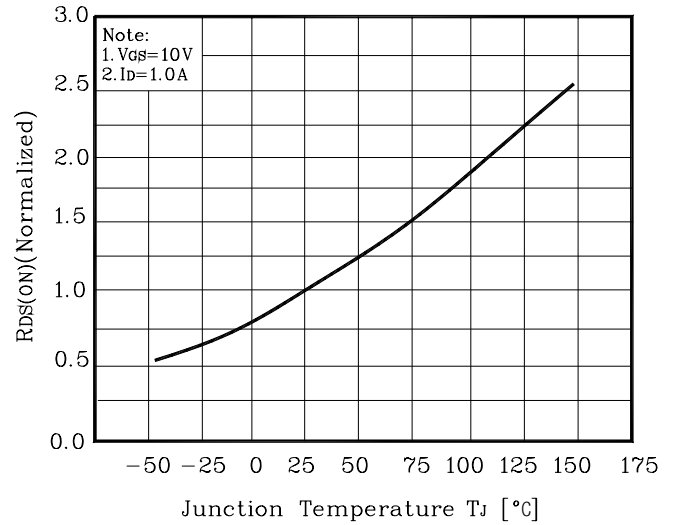
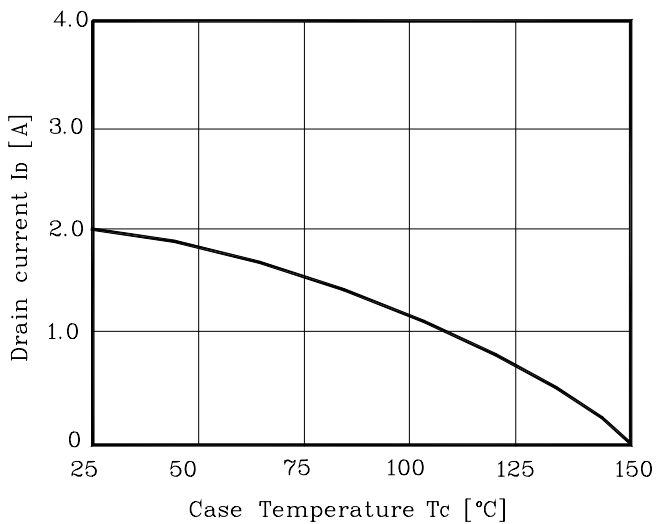
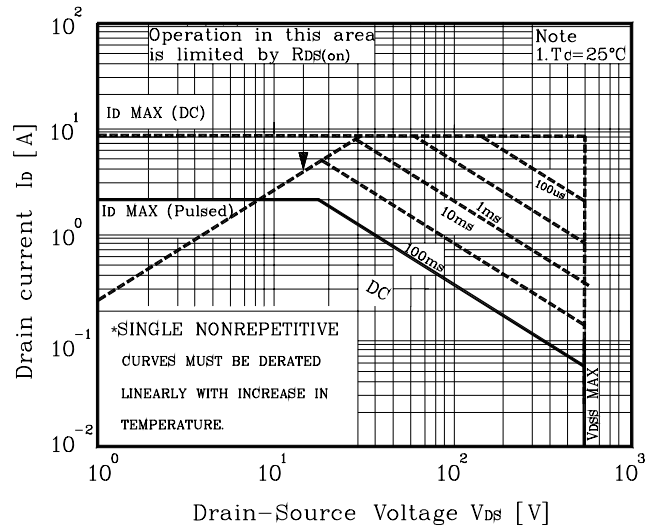
Fig. 12 Resistive Switching Test Circuit & Waveform

Fig. 13 EAS Test Circuit & Waveform

Fig. 14 Diode Reverse Recovery Time Test Circuit & Waveform

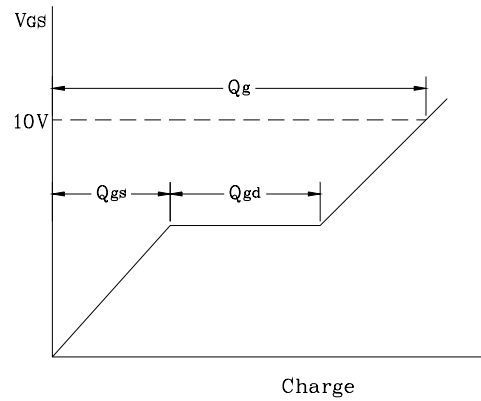
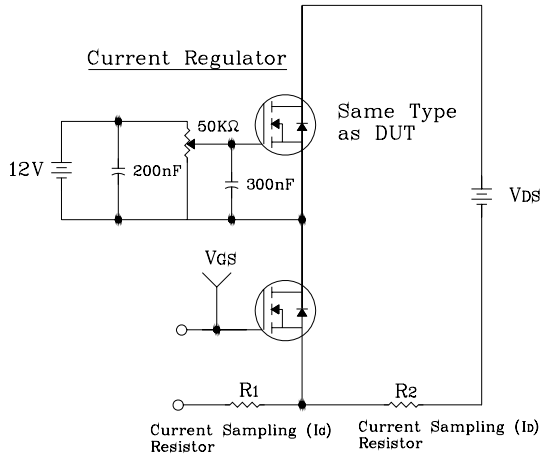
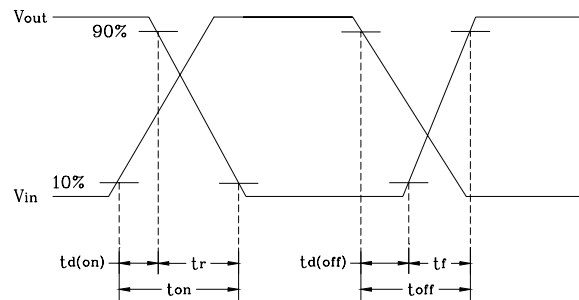
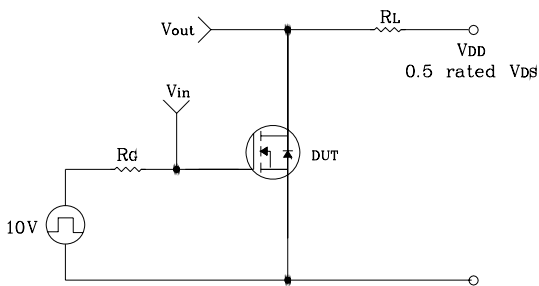
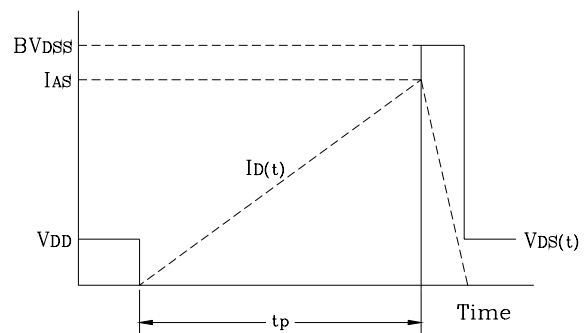
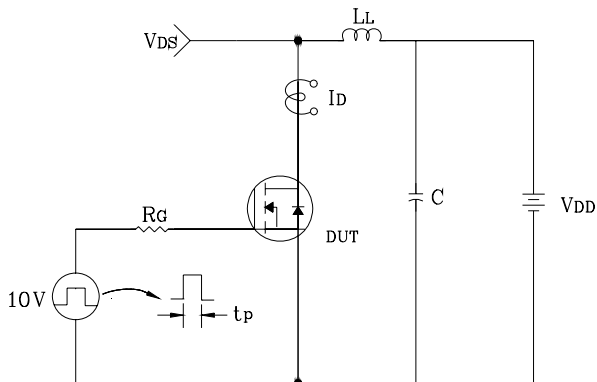
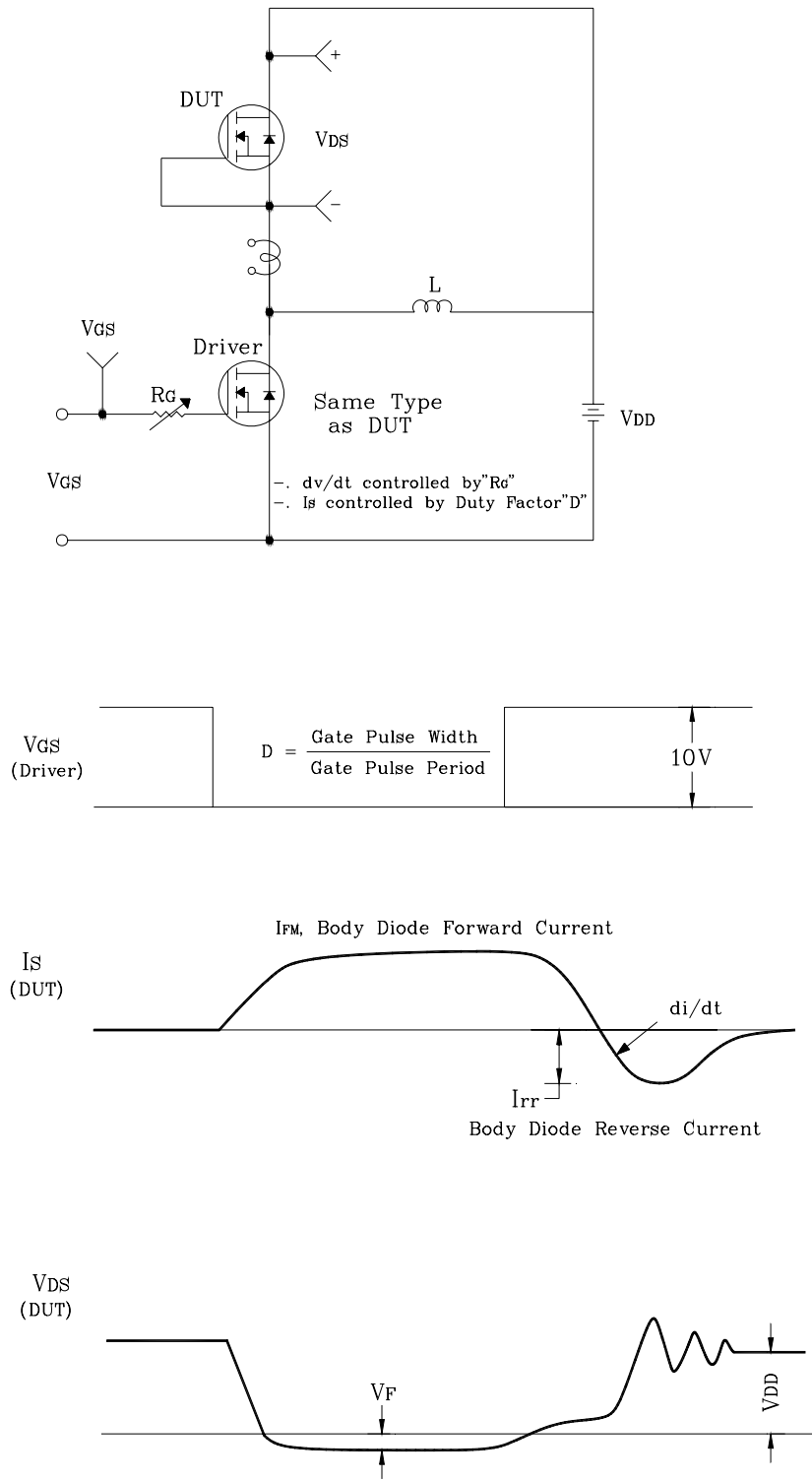
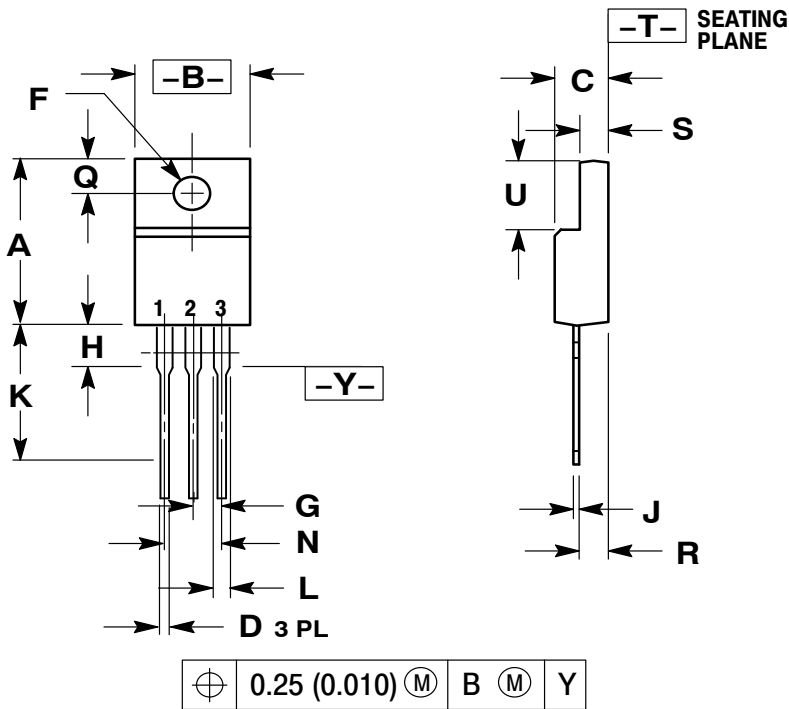

Package Dimensions

TO-220F



NOTES:

1. DIMENSIONING AND TOLERANCING PER ANSI Y14.5M, 1982.
2. CONTROLLING DIMENSION: INCH
3. 221D-01 THRU 221D-02 OBSOLETE, NEW STANDARD 221D-03.

DIM	INCHES		MILLIMETERS	
	MIN	MAX	MIN	MAX
A	0.617	0.635	15.67	16.12
B	0.392	0.419	9.96	10.63
C	0.177	0.193	4.50	4.90
D	0.024	0.039	0.60	1.00
F	0.116	0.129	2.95	3.28
G	0.100 BSC		2.54 BSC	
H	0.118	0.135	3.00	3.43
J	0.018	0.025	0.45	0.63
K	0.503	0.541	12.78	13.73
L	0.048	0.058	1.23	1.47
N	0.200 BSC		5.08 BSC	
Q	0.122	0.138	3.10	3.50
R	0.099	0.117	2.51	2.96
S	0.092	0.113	2.34	2.87
U	0.239	0.271	6.06	6.88